

Art. Nr. 2850496

1/7

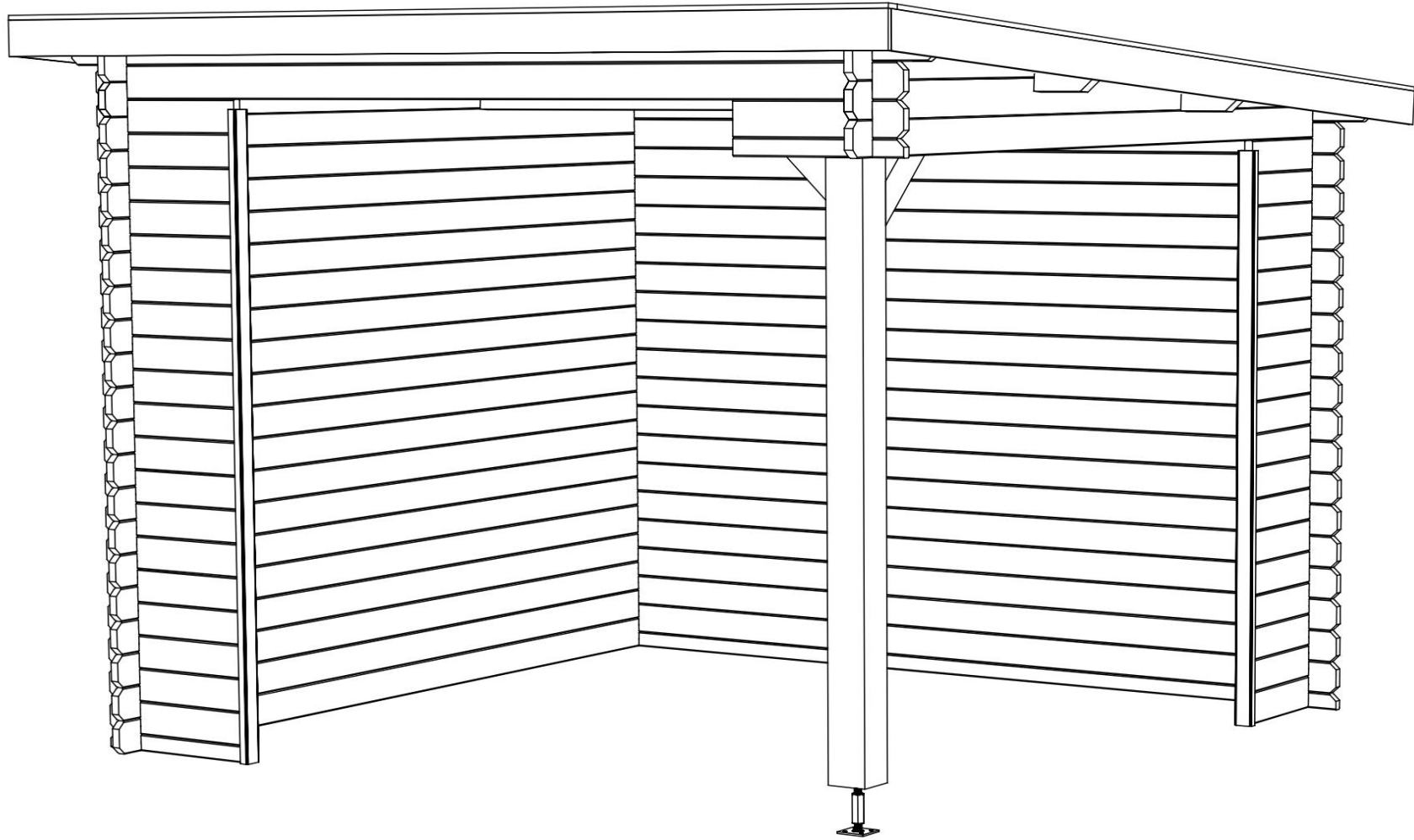

22.10.2023

Groundplan - Grundplan - Plan de masse -
Planimetria - Plattegrond - Põhiplaan

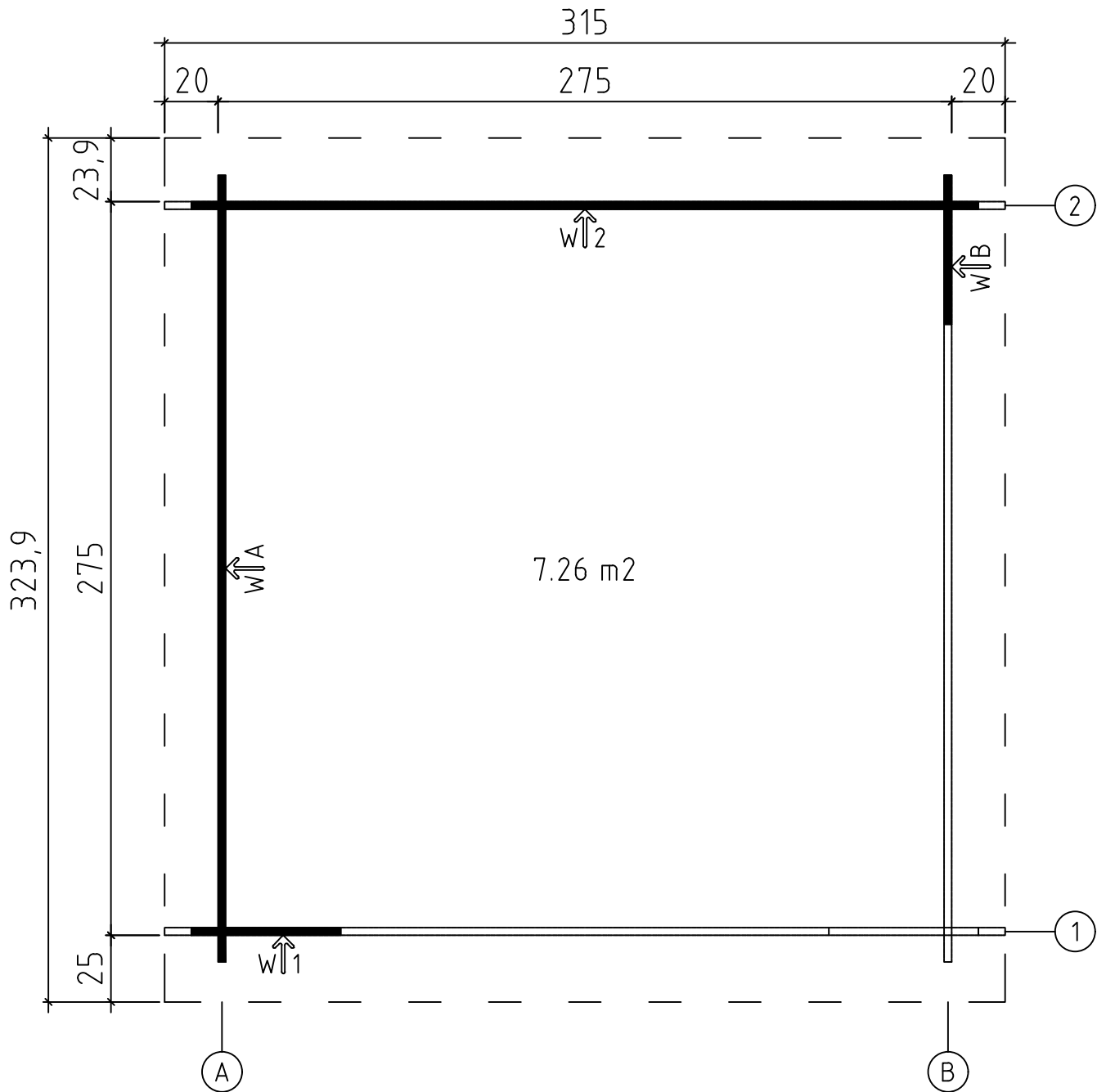

Art. Nr. 2850496

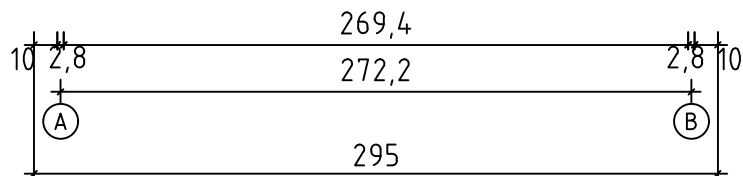
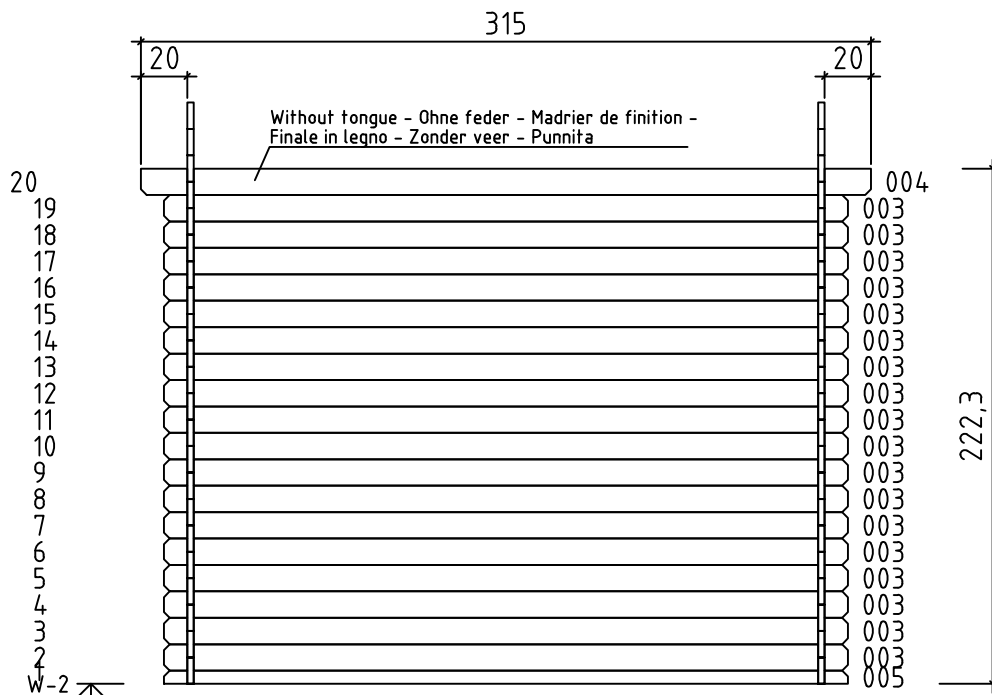
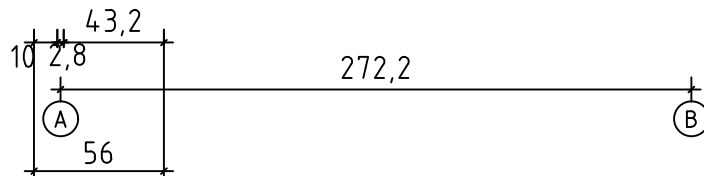
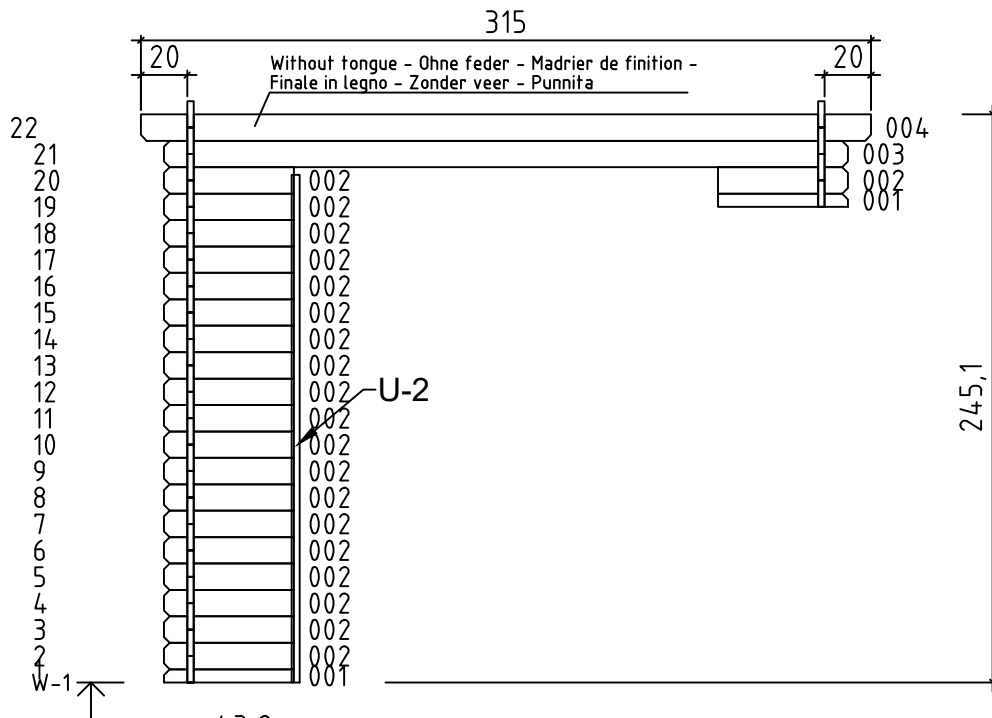

Art. Nr. 2850496

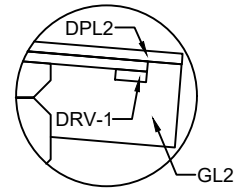
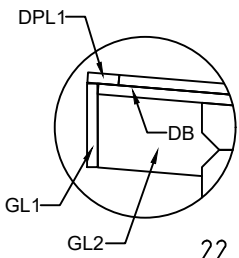

- 22
- 21
- 20
- 19
- 18
- 17
- 16
- 15
- 14
- 13
- 12
- 11
- 10
- 9
- 8
- 7
- 6
- 5
- 4
- 3
- 2
- 1

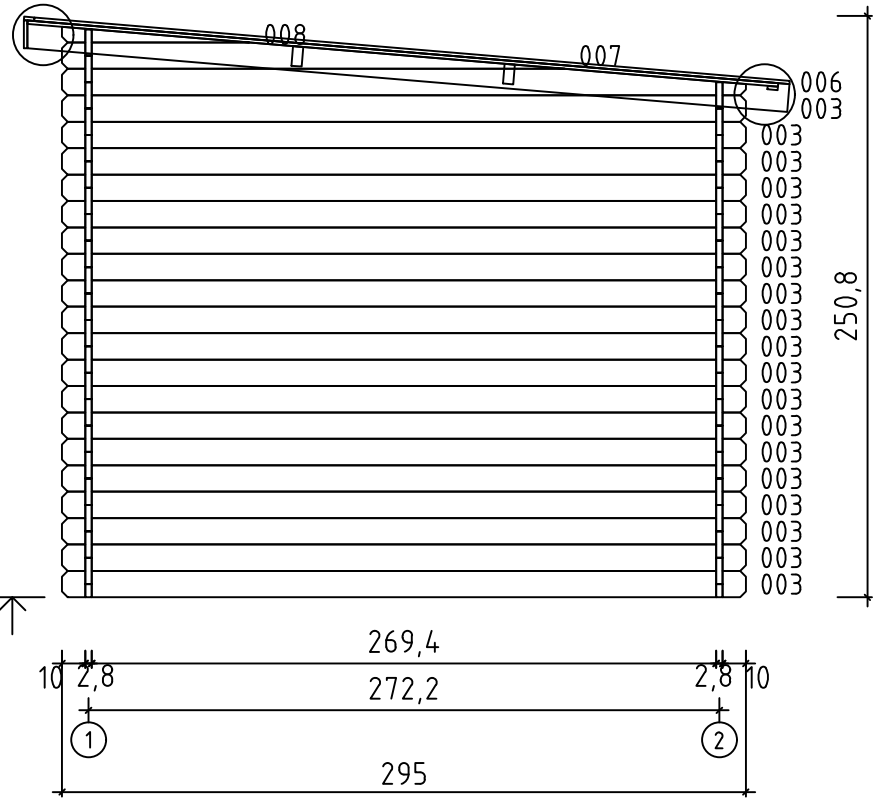





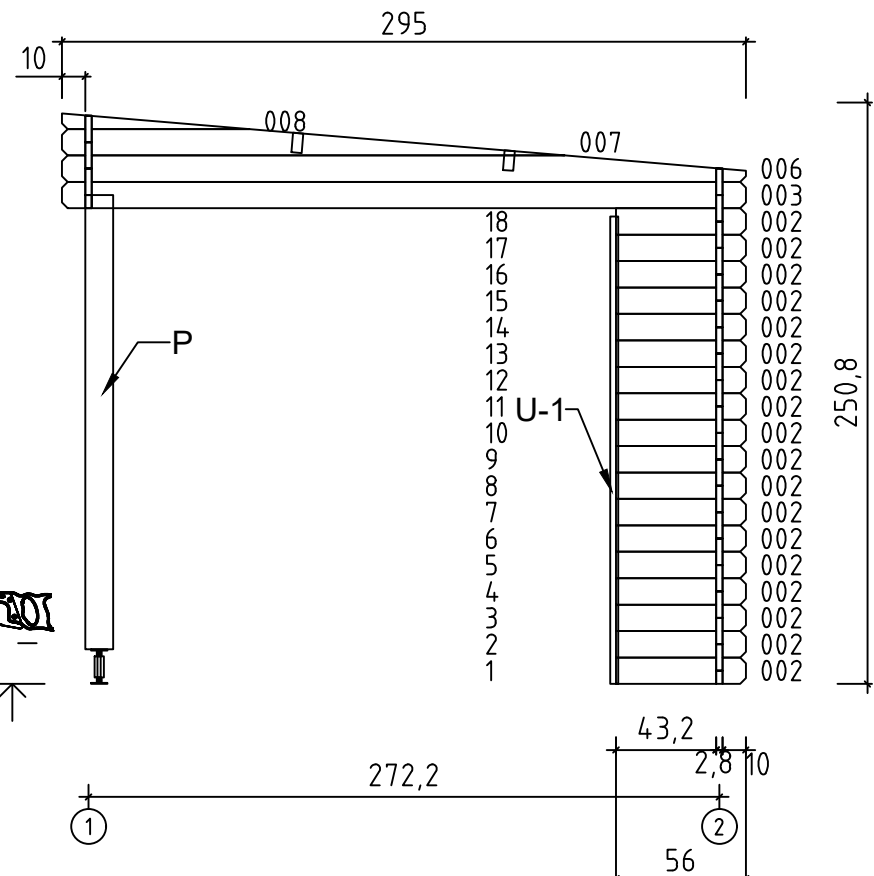



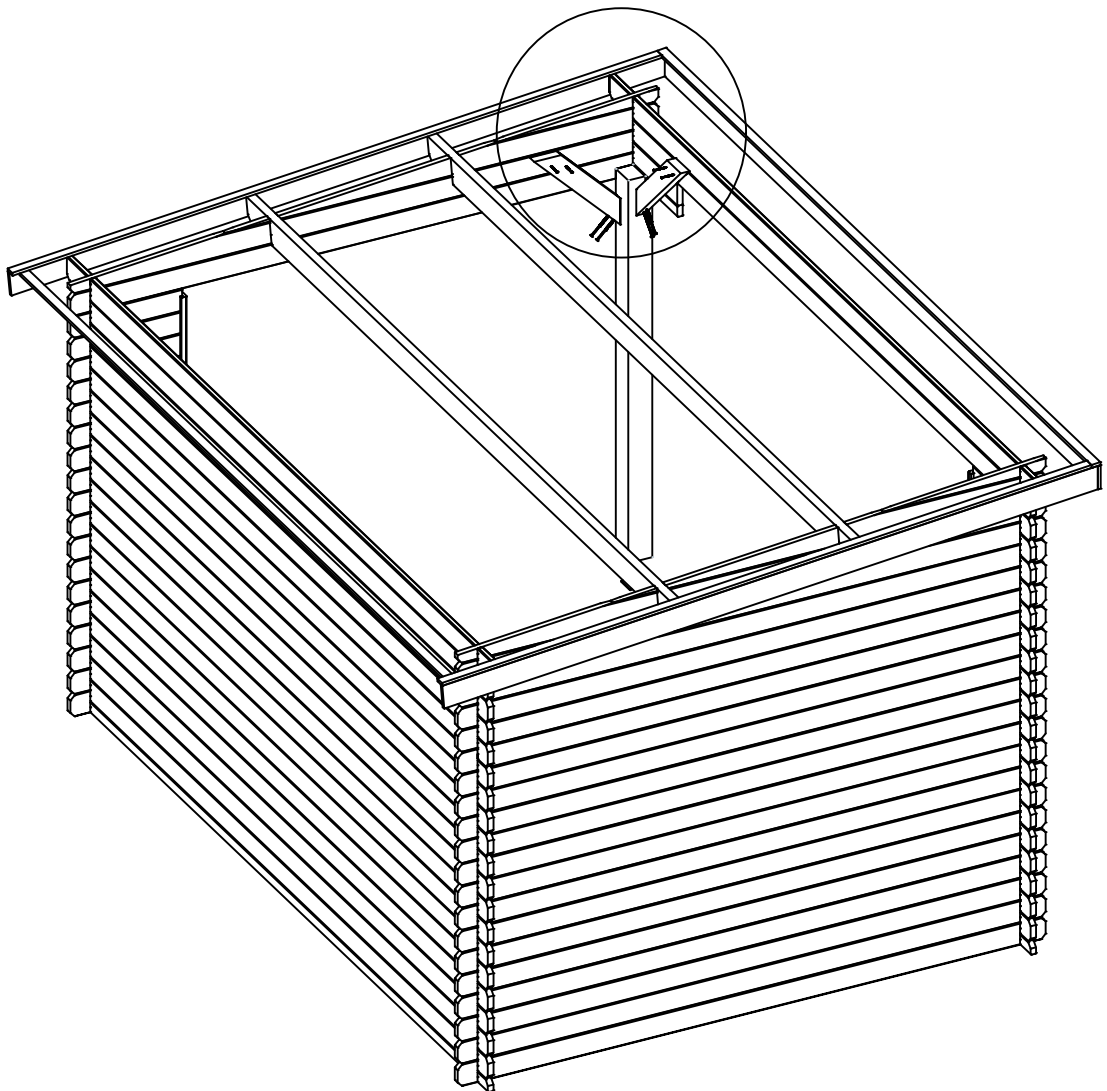
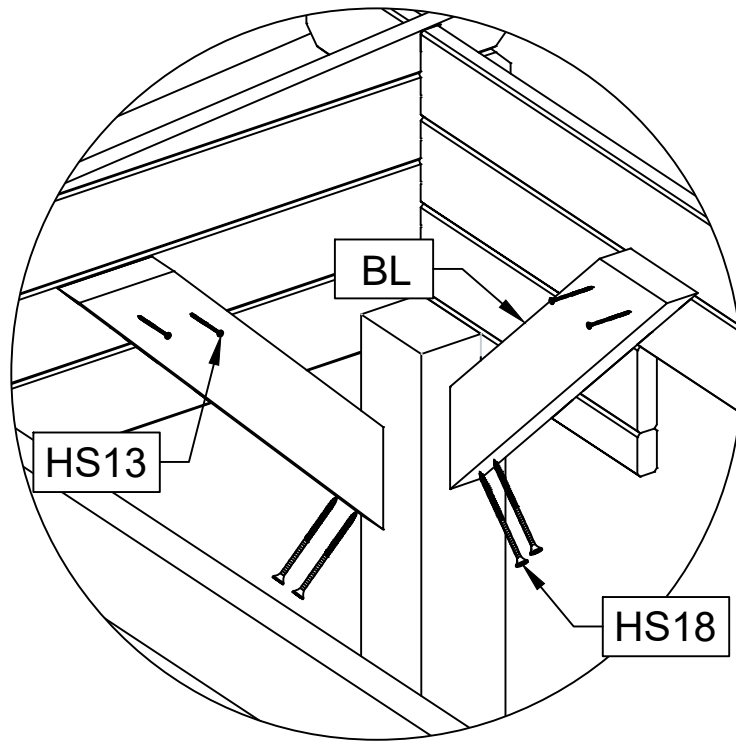

- 22
- 21
- 20
- 19
- 18
- 17
- 16
- 15
- 14
- 13
- 12
- 11
- 10
- 9
- 8
- 7
- 6
- 5
- 4
- 3
- 2
- 1

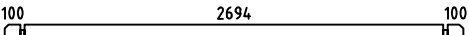
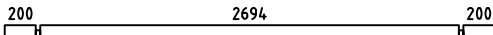
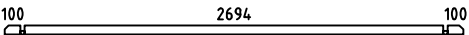
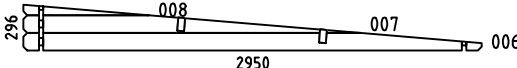
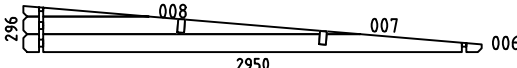
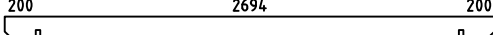
P=X-RP (150 mm)



22.10.2023

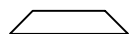
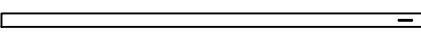

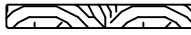
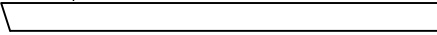
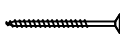
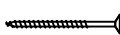
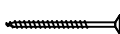
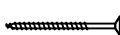
Pos	22.10.2023 Piece list - Stückliste - Liste des pièces - Elementi - Stuklijst - Tükítabel Art. Nr. 2850496 6/7	Q	P (mm)	L (mm)
001		2	28x57	560
002		38	28x114	560
003		39	28x114	2950
004		2	28x114	3150
005		1	28x57	2950
WA-1		1		
WB-1		1		
A-PR1	Roof beam - Dachbalken - Panne de toit - Perlina del tetto - Gordingen / dakbalk - Pärlin 	2	44x146	3150
DB	Roof boards - Dachbretter - Voliges - Perlina per tetto - Dakhout - Katuselaud 	35	90x15,5	3250
DPL1	Roofing felt fillet - Dachpappenleiste - Baguette de fixation du feutre bitumeux - Asse per fissaggio guaina bituminosa - Afdekljst asfaltpapier - Katusepapiilist 	1	15x45	3180
DPL2	Roofing felt fillet - Dachpappenleiste - Baguette de fixation du feutre bitumeux - Asse per fissaggio guaina bituminosa - Afdekljst asfaltpapier - Katusepapiilist 	2	15x45	3270
P	Post - Pfosten - Poteau - Piede registrabile - Stijl - Post 	1	120x120	2000
DRV-1	Roof edge reinforcement - Dachrandverstärkung - Corniere de renfort de bord de toit - Rinforzo x tetto - Dakrand versterking - Räästatugevdus 	1	15x45	3150
BL	Beam - Balkenlage - Solive(s) - Trave - Balk (gording) - Tala 	2	44x120	620
KFS-1	Storm protection - Sturmleiste - Latte anti-tempete - Protezione anti vento - Stormverankerung / beveiliging - Tormikinnitusliist 	3	22x45	2500
U-1	U-profile - U-profils - Profile u - Profilo ad u - U-profiel - U-profiil 	1	28x58	2017
U-2	U-profile - U-profils - Profile u - Profilo ad u - U-profiel - U-profiil 	1	28x58	2190
GL1	Gable moulding - Giebelleiste - Planche de rive - Finitura per frontale e retro del tetto - Gevellijst - Viilulaud 	1	15x120	3180
GL2	Gable moulding - Giebelleiste - Planche de rive - Finitura per frontale e retro del tetto - Gevellijst - Viilulaud 	2	15x120	3300
HS9	Screw for u-profile - Schraube zur befestigung u-profils - Vis a tete fraisée pour profil u - Vite per profilo ad u - Schroef ter bevestiging u-profiel - Kruvi U-profiilile 	12	3.5x50	
HS9	Screw for gable moulding - Schrauben für giebelleiste - Vis pour fixation planche de rive - Vite per fissare finiture davanti e dietro del tetto - Schroef voor gevellijst - Kruvi viilulauale 	24	3.5x50	
HS4	Screw for roof edge reinforcement - Schrauben für dachrandverstärkung - Vis pour fixation corniere renfort de bord de toit - Viti x rinforzo bordo tetto - Schroef voor dakrand versterking - Kruvi räästatugevdusele 	6	3x30	
HS13	Screw for beam - Schrauben zur befestigung dachsparren - Vis pour solive (s) - Viti per perline - Schroef voor balk (gording) - Kruvi talale 	4	4x60	

